

치수의 허용등급		
치수의구분(mm)		공차
이상	이하	±
-	3	0.08
3	6	0.1
6	10	0.1
10	18	0.12
18	30	0.15
30	50	0.15
50	80	0.2
80	120	0.25
120	180	0.35
180	250	0.45
250	-	0.6

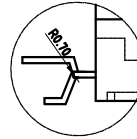

DETAIL "B"
SCALE 4:1

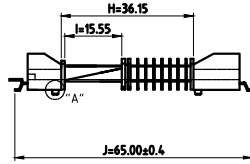
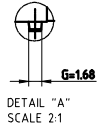
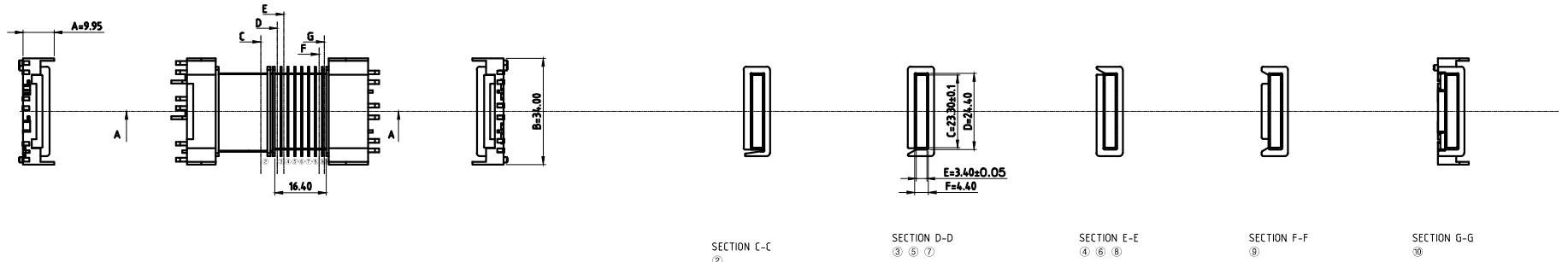
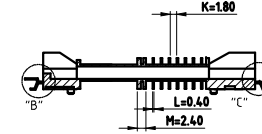

SECTION A-A

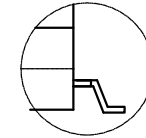

DETAIL "C"
SCALE 4:1

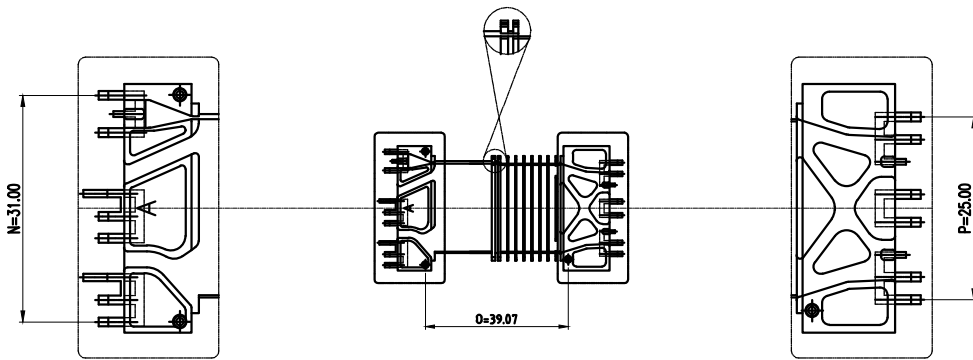

MARK	REVISION NOTE	DATE	DRAWN	CHECKED	APPROVED
△					
△					
△					
△					
DRAWN	CHECKED	APPROVED	MATERIAL : LCP	UL REC. : UL94V-0	THIRD ANGLE PROJ. SCALE : 1/1
Dea Soo, Kim	Hyoung Seok, Lee	Hyoung Seok, Kim	DATE : 2008.07.21	TOLERANCE : ±0.2 (Unless otherwise specified)	UNIT : m/m
주식회사 대흥보빈 DAE HEUNG BOBBIN CO., LTD			TITLE CI 32*50 B-4		DWG NO DH-080721-7038-04